



JUREN PRODUCT MANUALS

www.jurendianli.com

JR-19-10-A/0

RWYII-D

RWII - D

RWII - D

300- 500g,
35mm

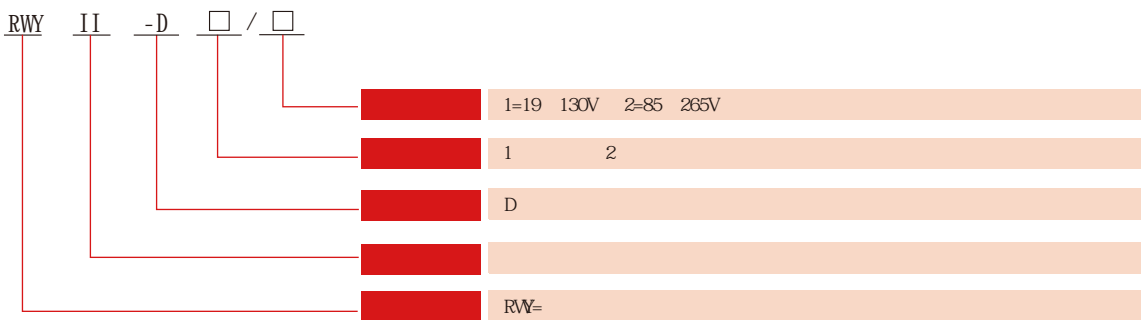

RWII - D1/19 130V

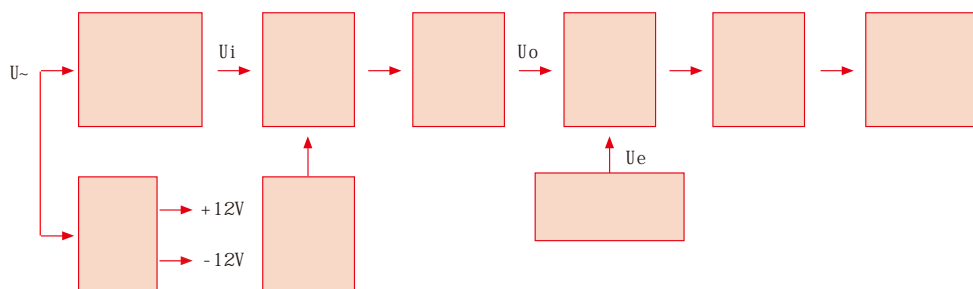

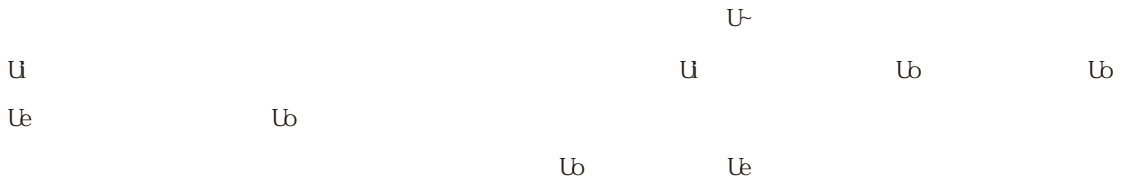

- 100V/50Hz
- 1.2
- 19V 130V 85V 265 180V 440V 1V
- 1.5VA 100V
- a 3% = (5 -) / × 100%
- b 5 4%
- c - 10 50 4%
- a 1.2 40ms 2 35ms
- a 0.85 0.95
- b 1.02 1.12
- 27ms

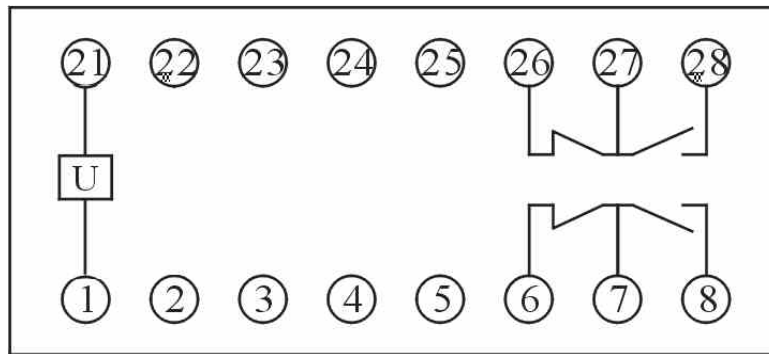

RWI-D 2

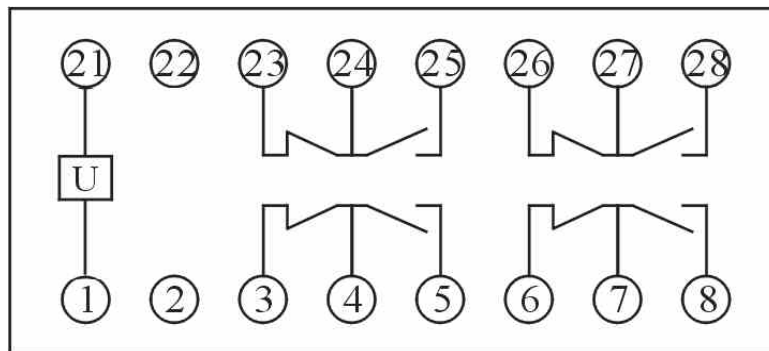

RWI-D 4

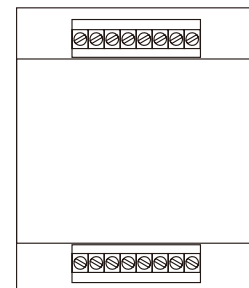
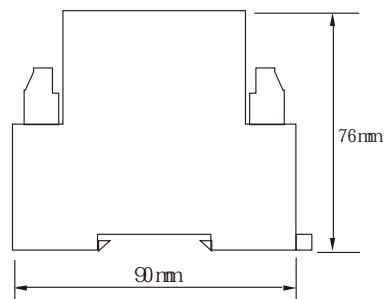
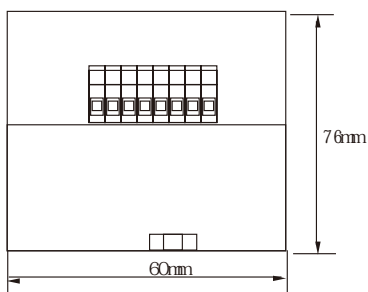

ABOUT US
JUREN POWER

1999

