



# RVII-D

RVII-D ( )

RVI - D

300- 500g,  
35mm

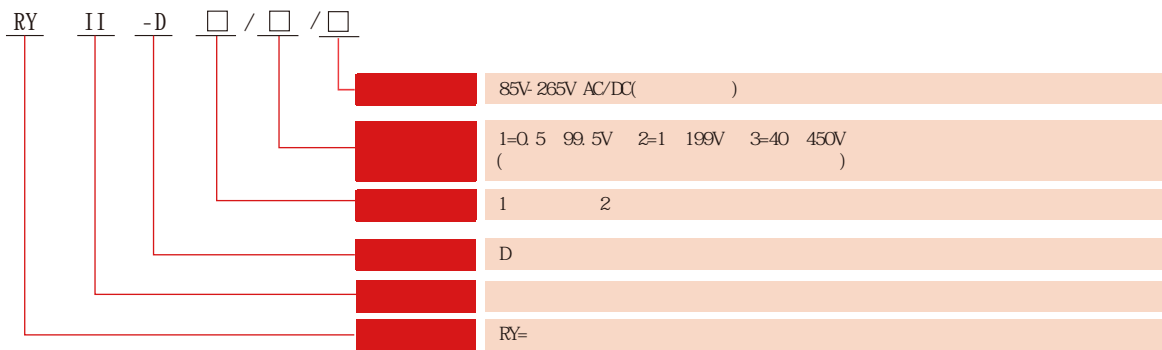

RVI - D1/1 85 265VAC/DC

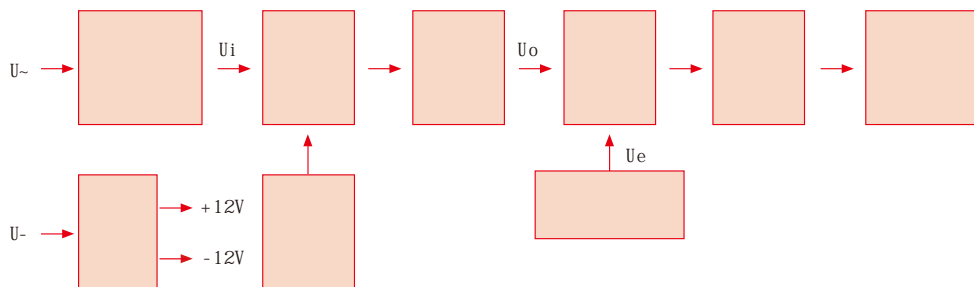

$U_{le}$                        $U_{b}$                        $U_{le}$                        $U_{b}$                        $U_{le}$                        $U_{b}$

- 85V 265VAC/DC
- 1.2
- 0.5 99.5V , 0.1V 1 199V 1V 40 450V 1V
- 
- a 1W ( 100V )
- b

(V)	(W)	
220	2	4
110	1	2

- 
- a 1V 440V 3% = ( 5 - ) / × 100%
- b 5 4%
- c - 10 50 4%
- d 80 110% 4%
- 
- a 1.2 25ms 2 20ms
- b 0.5 20ms
- 
- a 0.85 0.95
- b 1.02 1.12
- 27ms

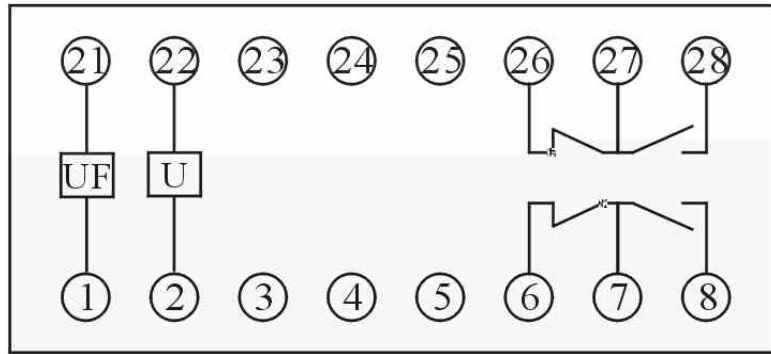

RMI-D 2

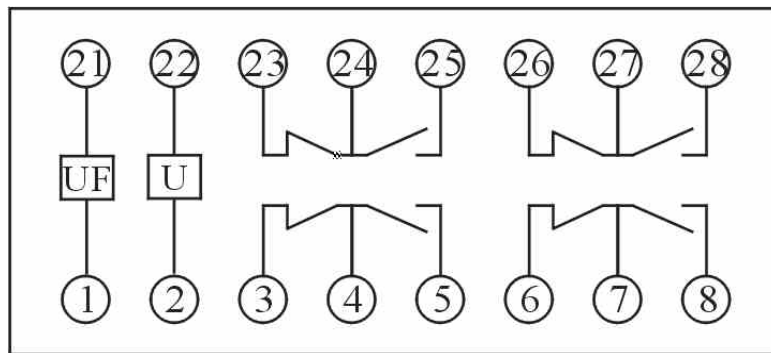

RMI-D 4

UF

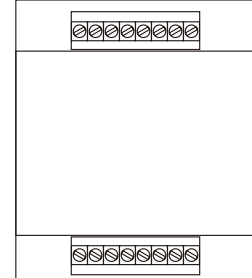
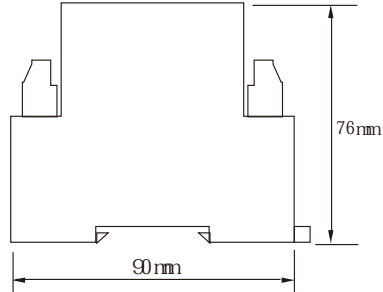
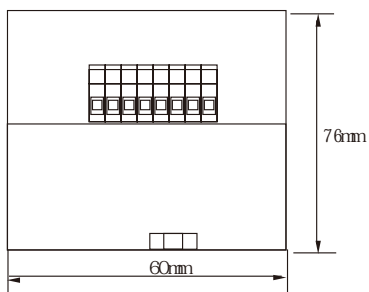

ABOUT US  
**JUREN POWER**

---

1999

